BuzziLand

Product Specification Sheet

This document contains technical information about the BuzziLand



Dampen sounds without losing out on chic design

Large office spaces or residential lofts often echo. This is an irritating problem which does little to encourage hard work or make a space cosy. BuzziSpace has developed the BuzziLand and BuzziPod in sound-insulating material: stick them to the ceiling or walls to dampen sounds without losing out on chic design.

Design by BuzziSpace Studio

General

BuzziLand

Shape: Oval, Round, Virgule

- Pattern: Oval: Flat, Rib
 - Round: Flat, 3D Rib, 3D Drop, 3D Leaf
 - Virgule: Flat
- Fixing: Wall | Pendant

Core: Honeycomb cardboard

- Filling: CME35H foam
- Upholstery: Fabric, Rough, Terra
- Back: antiskid (black with BuzziSpace logo)

Oval: S: 80 x 120 cm | 31.50" x 47.24"

M: 80 x 160 cm | 31.50" x 62.99"

L: 100 x 180 cm | 39.37" x 70.87"

XL: 120 x 200 cm | 47.24" x 78.74"

Round: S: Ø 80 cm | Ø 31.50"

M: Ø 100 cm | Ø 39.37"

L: Ø 120 cm | Ø 47.24"

Virgule: 180 x 105 cm | 70.87" x 41.24"

- Fixation: wall mounted | ceiling pendant: Fixing System Screw or Fixing System Magnet
- Black or Alu cables 2 - 5 m | 78.74" - 196.85"

- ⚠ If installing on suspended ceiling, verify load capacity prior to installation.

Acoustics



Absorption

Content

Configurations	3	Fixing Systems	7
Patterns	5	Dimensions	8
Fabrics	6	Acoustics	14

Configurations

BuzziLand Oval

S, M, L, XL

◆ Pattern: Flat, 3D Rib
Fixing: wall mounted or ceiling suspended

Core: Honeycomb cardboard
Filling: CME35H foam
🌲 Cover: Fabric, Rough, Terra
Back: antiskid (black with white BuzziSpace logo)

✂ S: H 80 cm W 120 cm | H 31.50" W 47.24"
M: H 80 cm W 160 cm | H 31.50" W 62.99"
L: H 100 cm W 180 cm | H 39.37" W 70.87"
XL: H 120 cm W 200 cm | H 47.24" W 78.74"

⚖ Flat | 3D: S: 4,5 kg | 9.92 lbs
M: 5,8 kg | 12.79 lbs
L: 7,5 kg | 16.53 lbs
XL: 9,5 kg | 20.94 lbs

Fixation: wall mounted: Fixing System Wall
... ceiling suspended: Fixing System Screw
Fixing System Magnet
Black or Alu cables 2 - 5 m | 78.74" - 196.85"

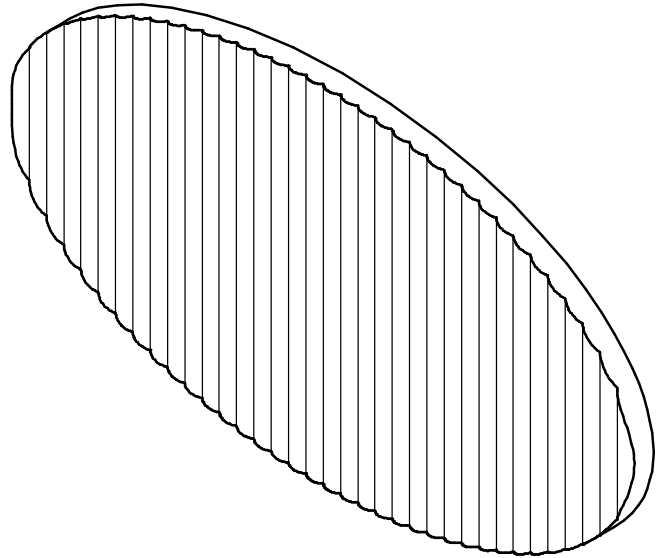

BuzziLand Round

S, M, L

◆ Pattern: Flat | 3D: Rib, Drop, Leaf

Core: Honeycomb cardboard
Filling: CME35H foam
🌲 Cover: Fabric, Rough, Terra
Back: antiskid (black with white BuzziSpace logo)

✂ S: Ø 80 cm | Ø 31.50"
M: Ø 100 cm | Ø 39.37"
L: Ø 120 cm | Ø 47.24"

⚖ Flat | 3D: S: 3,3 kg | 7.28 lbs
M: 4,6 kg | 10.14 lbs
L: 6,3 kg | 13.89 lbs

Fixation: wall mounted: Fixing System Wall
... ceiling suspended: Fixing System Screw
Fixing System Magnet
Black or Alu cables 2 - 5 m | 78.74" - 196.85"

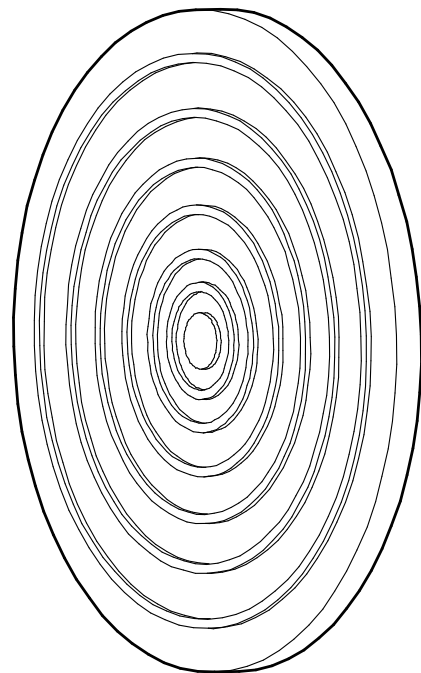

BuzziLand Virgule

- ◆ Flat
- 🌲 Core: Honeycomb cardboard
Filling: CME35H foam
Cover: Fabric, Rough, Terra
Back: antiskid (black with white BuzziSpace logo)
- ✂ W 180 cm H 105 cm | W 70.87" H 41.34"
- ⚖ 7 kg | 15.43 lbs
- *** Fixation: wall mounted: Fixing System Wall
ceiling suspended: Fixing System Screw
Fixing System Magnet
Black or Alu cables 2 - 5 m | 78.74" - 196.85"

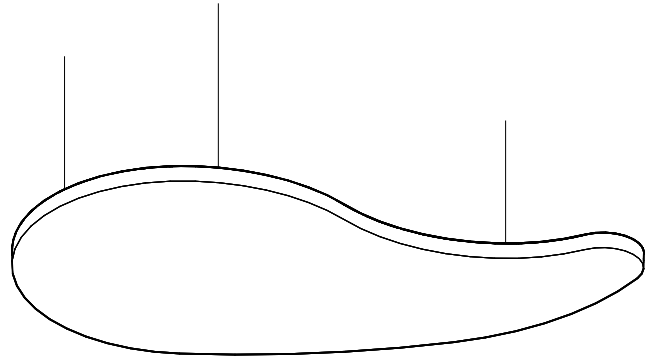

Patterns

Oval

Flat

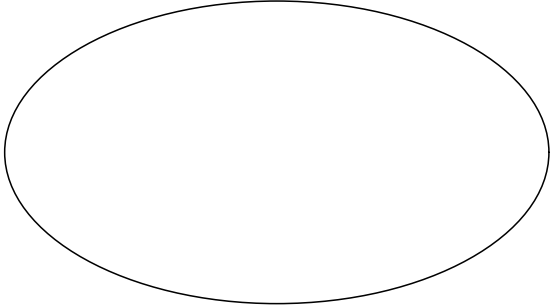

Rib

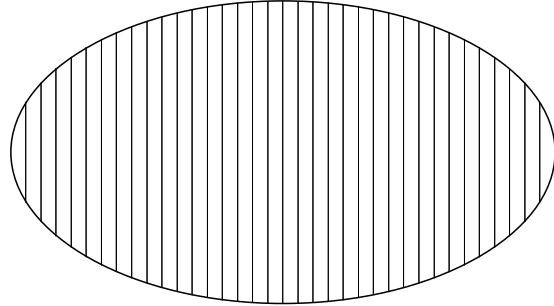

Round

Flat

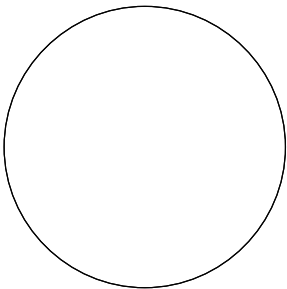

Rib

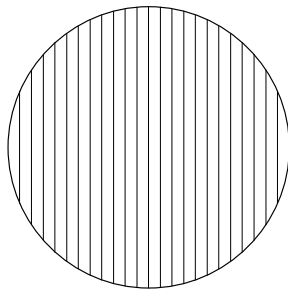

Drop

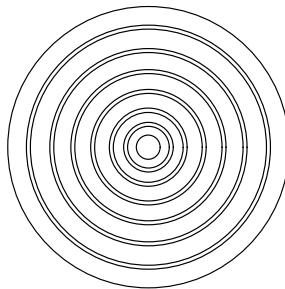

Leaf

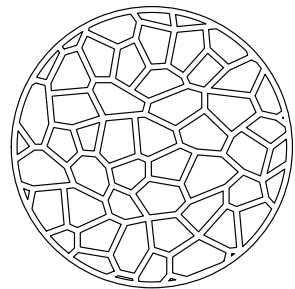

Virgule

Flat

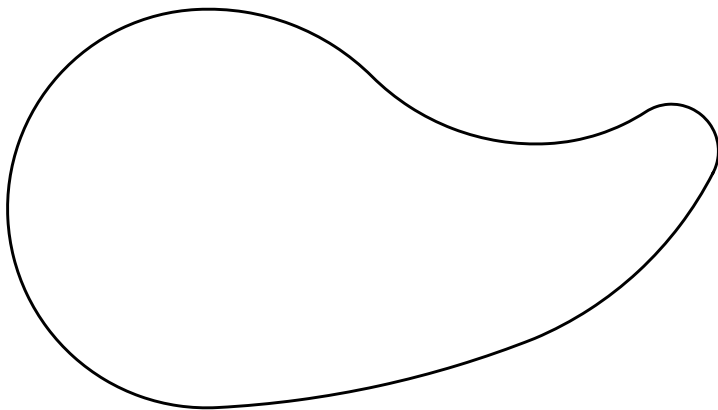

Fabrics

Fabric

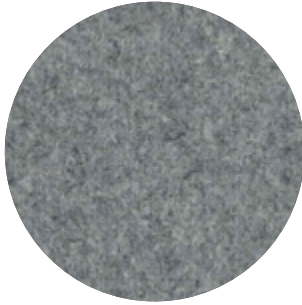

Category A

Composition 70% Recycled Wool, 25% Recycled Polyacryl,
5% Recycled Other Fabrics

Weight 405 g/m² | 11.94 oz/yd²

Abrasion resistance 40.000 Martindale, 50,000 Wyzenbeek

Flammability EU: EN 1021.1/2006 | BS EN 1021.1/2006 (cigarette).
EN 1021.2/2006 | BS EN 1021.2/2006 (match)
USA: CAL TB 117 | ASTM E84 CLASS A

Fastness to light EU: 4 | USA 4

Fastness to rubbing EU: Wet 3-4 | Dry 4-5

Fastness to crocking USA: Wet 5 | Dry 5



Rough

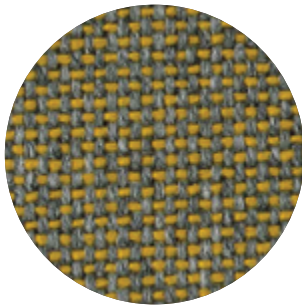

Category A

Composition 100% Polyacryl

Weight 456 g/m² | 13.45 oz/yd²

Abrasion resistance 40.000 Martindale

Flammability EU: EN 1021.1/2006 | BS EN 1021.1/2006 (cigarette)
USA: CAL TB TB 117

Fastness to light EU: 5

Fastness to rubbing EU: Wet: 3 | Dry: 3



Terra

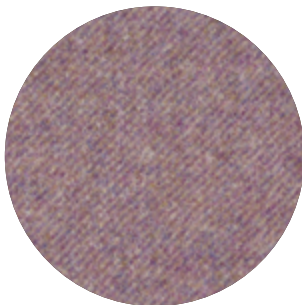

Category B

Composition 100% Pure New Wool

Weight 370 g/m² | 10.91 oz/yd²

Abrasion resistance 40.000 Martindale, 25,000 Wyzenbeek

Flammability EU: BS5852 CRIB 5 | BS5867 PART 2 : 2008 : TYPE B
EN: 1021.2/2006 | USA: CAL TB 117

Fastness to light EU 5 | USA 5

Fastness to rubbing EU: Wet 4 | Dry 4

Fastness to crocking USA: Wet 4 | Dry 4



Antiskid (back only)



Fixing Systems

Fixing System Wall (optional)

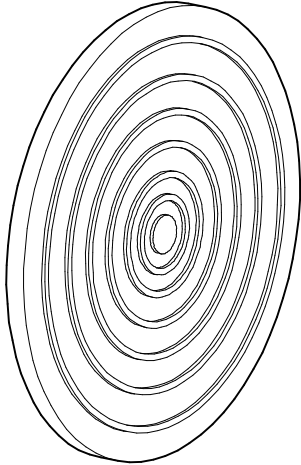

2x2 wooden brackets (excl. screws)
(No wall mounting possible for Virgule)

Fixing System Ceiling Suspended (optional)

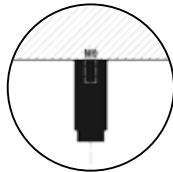
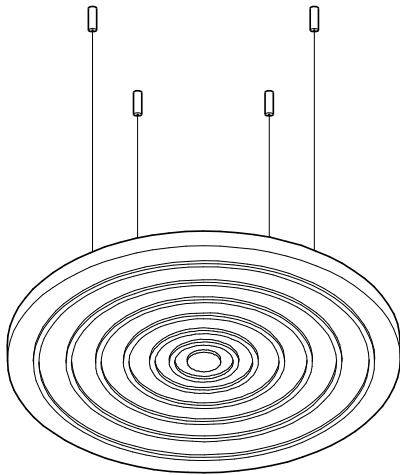

Fixing System Screw

4 cables of 2 - 5 m | 78.74" - 196.85"
Black or aluminium coloured cables
(Buzziland Virgule: 3 cables)

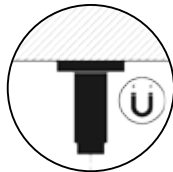
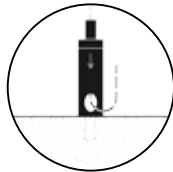

Fixing System Magnet

4 cables of 2 - 5 m | 78.74" - 196.85"
Black or aluminium coloured cables
(Buzziland Virgule: 3 cables)

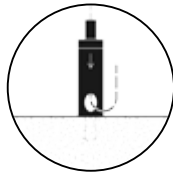

*1 magnet (Ø 3,2 cm H 0,8 cm | Ø 1.26" H 0.31") can take up to 10 kg | 22.05 lbs when hanging on a solid metal surface.

Dimensions

Oval

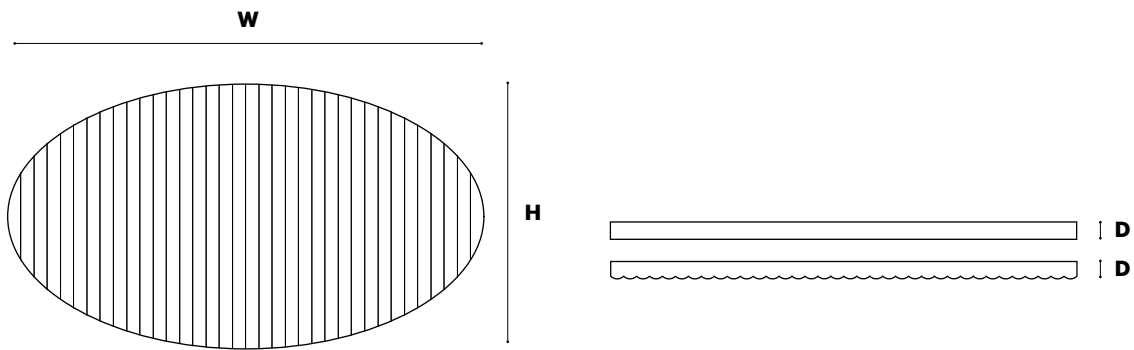

S	H 80 cm	W 120 cm	Flat + 3D: D 6,5 cm
	H 31.50"	W 47.24"	Flat + 3D: D 2.56"
M	H 80 cm	W 160 cm	Flat + 3D: D 6,5 cm
	H 31.50"	W 62.99"	Flat + 3D: D 2.56"
L	H 100 cm	W 180 cm	Flat + 3D: D 6,5 cm
	H 39.37"	W 70.87"	Flat + 3D: D 2.56"
XL	H 120 cm	W 200 cm	Flat + 3D: D 6,5 cm
	H 47.24"	W 78.74"	Flat + 3D: D 2.56"

Round



S	Ø 80 cm	Flat + 3D: D 6,5 cm
	Ø 31.50"	Flat + 3D: D 2.56"
M	Ø 100 cm	Flat + 3D: D 6,5 cm
	Ø 39.37"	Flat + 3D: D 2.56"
L	Ø 120 cm	Flat + 3D: D 6,5 cm
	Ø 47.24"	Flat + 3D: D 2.56"

Virgule

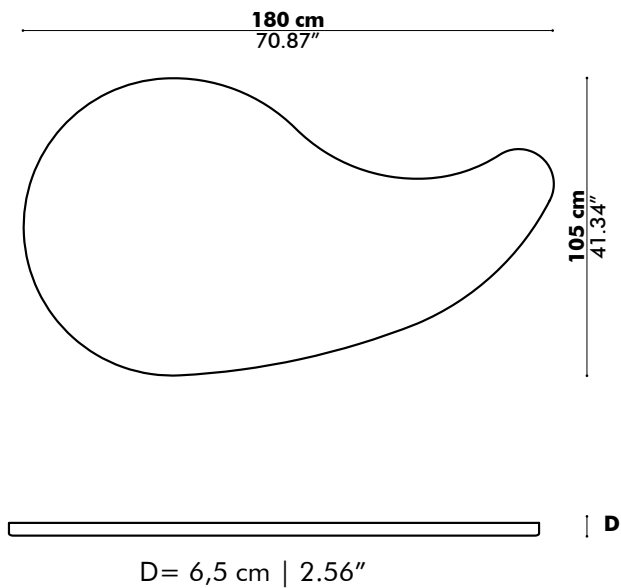

Dimensions Fixing System Wall

Oval

S
 H 80 cm W 120 cm
 H 31.50" W 47.24"

Horizontal use

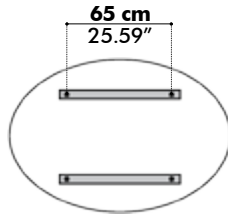
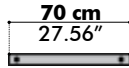

Vertical use

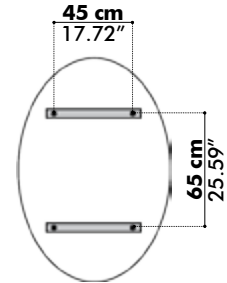
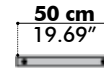

M
 H 80 cm W 160 cm
 H 31.50" W 62.99"

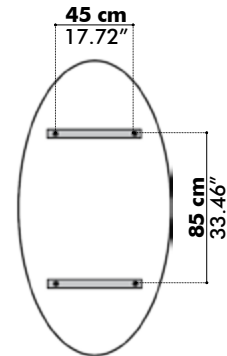
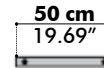
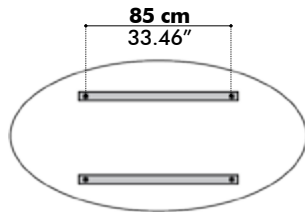
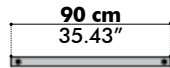

L
 H 100 cm W 180 cm
 H 39.37" W 70.87"

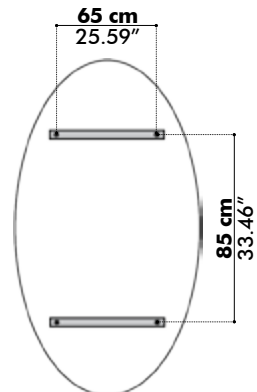
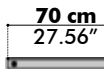
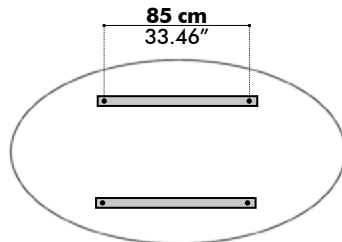
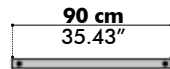

XL
 H 120 cm W 200 cm
 H 47.24" W 78.74"

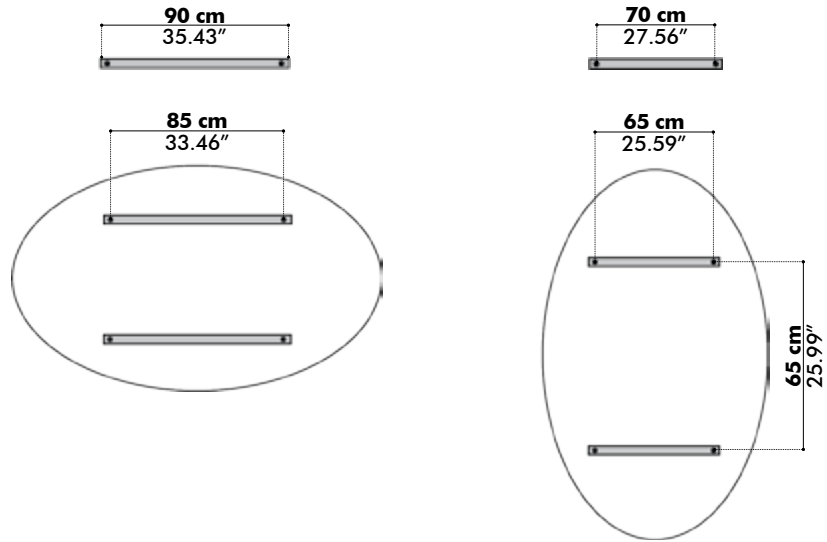

Round

S
 Ø 80 cm
 Ø 31.50"

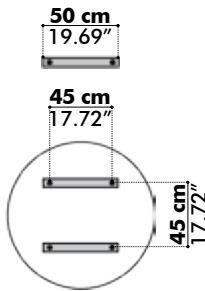

M
 Ø 100 cm
 Ø 39.37"

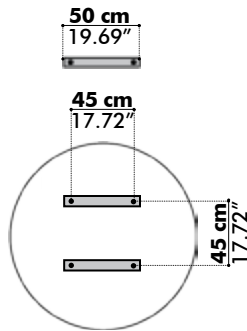

L
 Ø 120 cm
 Ø 47.24"

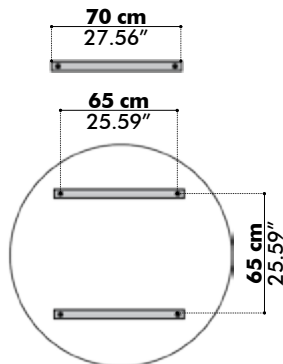

Dimensions Fixing System Suspended

Oval

S

H 80 cm W 120 cm
H 31.50" W 47.24"

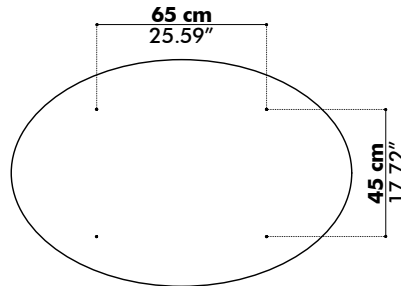

M

H 80 cm W 160 cm
H 31.50" W 62.99"

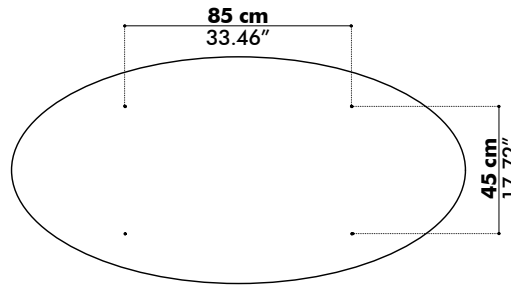

L

H 100 cm W 180 cm
H 39.37" W 70.87"

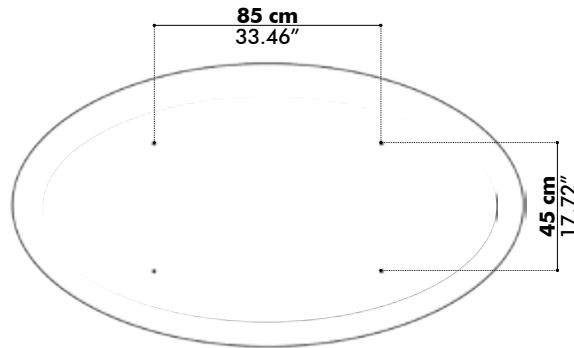

XL

H 120 cm W 200 cm
H 47.24" W 78.74"

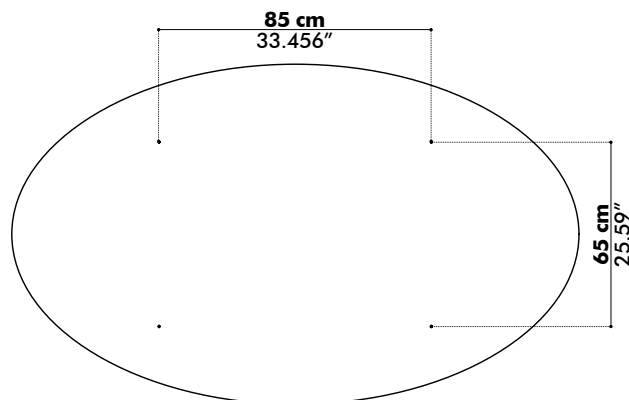

Round

S
Ø 80 cm
Ø 31.50"

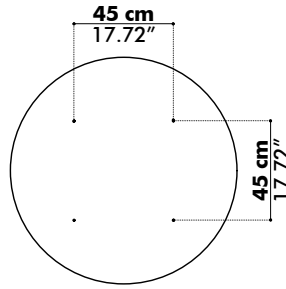

M
Ø 100 cm
Ø 39.37"

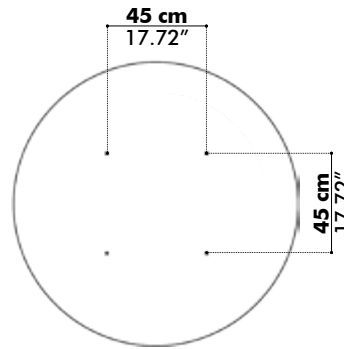

L
Ø 120 cm
Ø 47.24"

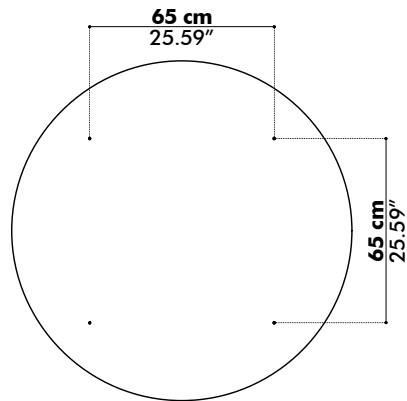

Virgule

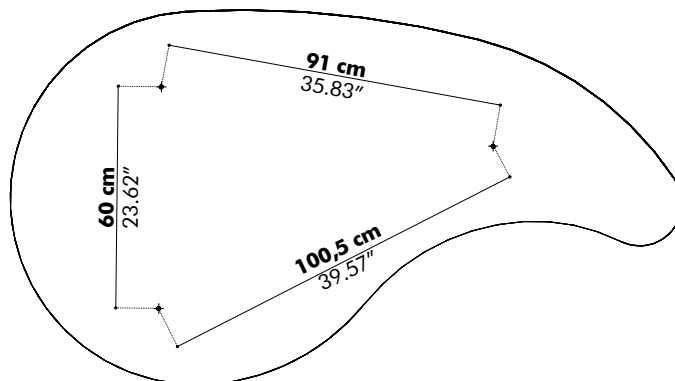

Acoustics

BuzziLand

Absorption coefficient

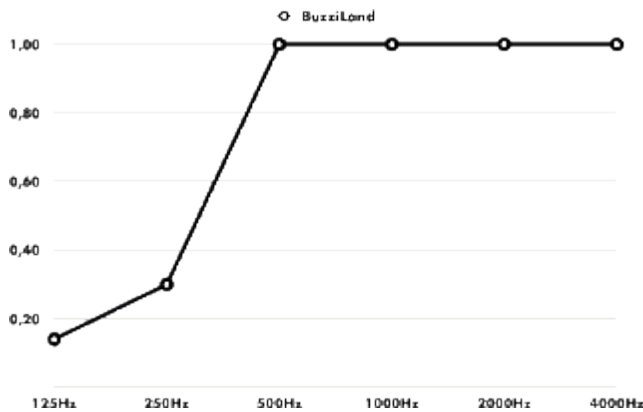

Hz	α^s
125	0.14
250	0.30
500	1.00
1000	1.00
2000	1.00
4000	1.00

Absorption Values

α_w (ISO 11654) **0.65**

NRC (ASTM - C423) **0.85**

SAA (ASTM - C423) **0.81**

Class (ISO 11654) **B**

Equivalent sound absorption area in m² per object

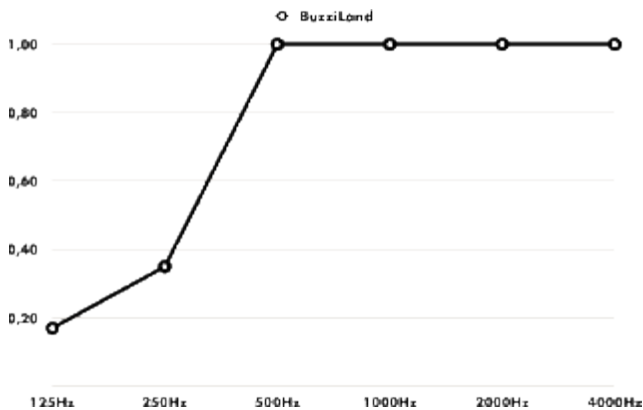

Hz	Aeq/m ²
125	0.17
250	0.35
500	1.00
1000	1.00
2000	1.00
4000	1.00

Glossary

All calculations are based on accredited lab measurements, official document available on www.buzzi.space

Definitions

α	Weighted absorption coefficient	(ISO 11654)
NRC	Noise reduction coefficient	(ASTM - C423)
SAA	Sound absorption average	(ASTM - C423)

Classification of sound absorbers NEN-EN-ISO 11654

A	0.90 0.95 1.0
B	0.80 0.85
C	0.60 0.65 0.70 0.75
D	0.03 0.55
E	0.15 0.25